



Apps tandem for scalable optimization of network energy efficiency

Paweł KRYSZKIEWICZ

All things wireless ●

Agenda

- Energy efficiency topic within Open RAN
- Limitations of existing Cells ON/OFF Switching algorithms
- Apps tandem as a scalable solution for COOS
- Apps tandem vs current O-RAN standard



Energy efficiency within Open RAN

Option 1: RF Channel Reconfiguration

- For M-MIMO
- Possible either in Non-RT RIC or Near-RT RIC
- Before June 2024: Standard not specific for Near-RT RIC yet.
- Not every hardware ready

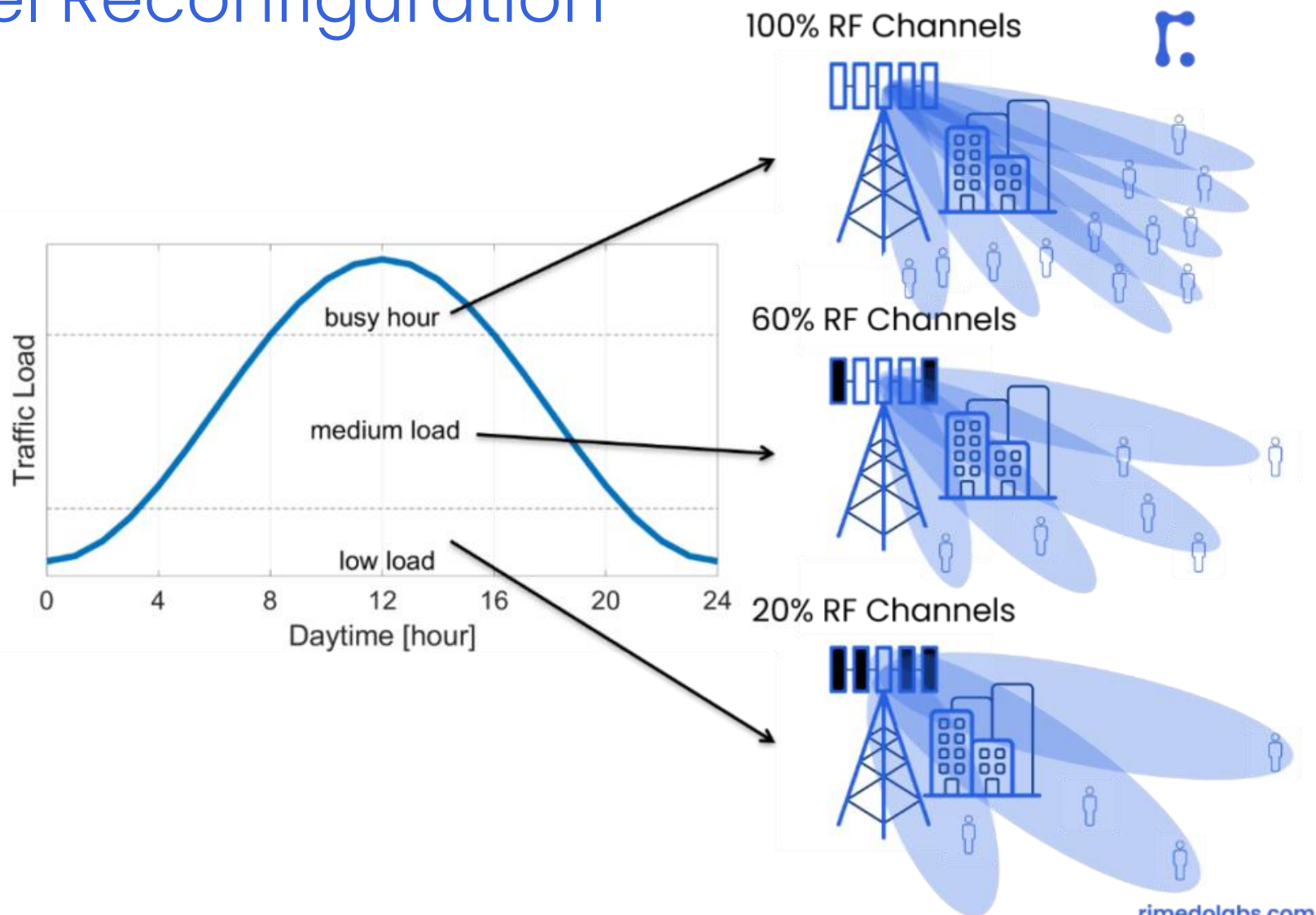

Option 2: Advanced Sleep Mode

- turn OFF for O-RU over an OFDM symbol (ASM1), slot (ASM2) or frame (ASM3)
- for Near-RT RIC, under development in the standard
- too complex for standard implementations (hardware)
- recall this decision influences the scheduler- maybe some coordination is needed. Cannot collide with periodic control signals

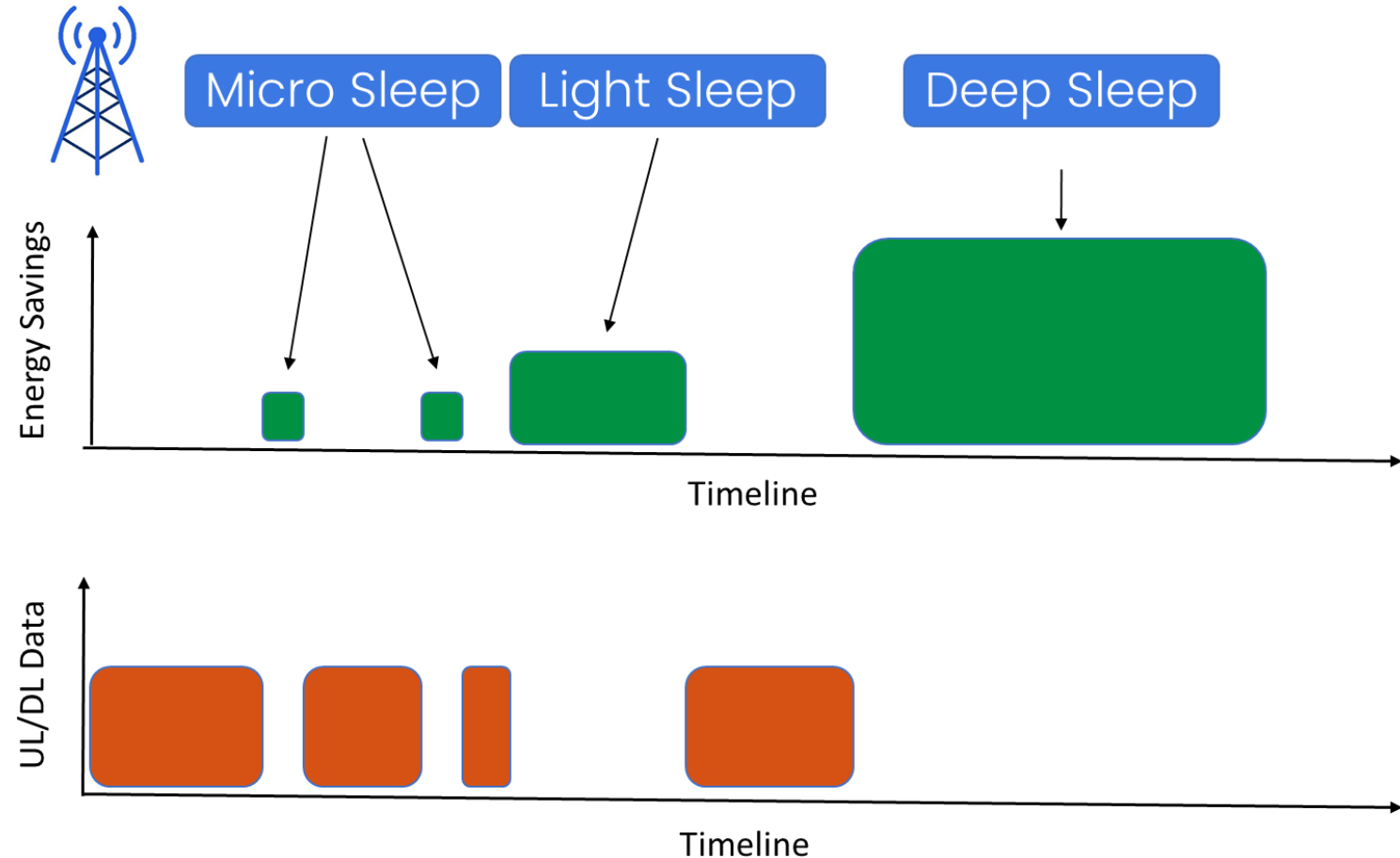

Option 3: Cell ON/OFF Switching

- Turns off a single cell/carrier
- Mostly standardized and available in RIC/RAN emulator platforms
- Less flexible than other Energy Saving methods
- Simple radio hardware possible (even legacy, non-O-RAN)
- Multiple algorithms for this purpose:
 - Survey from 2015: around 160 cited papers
 - Self Organizing Networks: reference design [simpler but closer to real implementation]

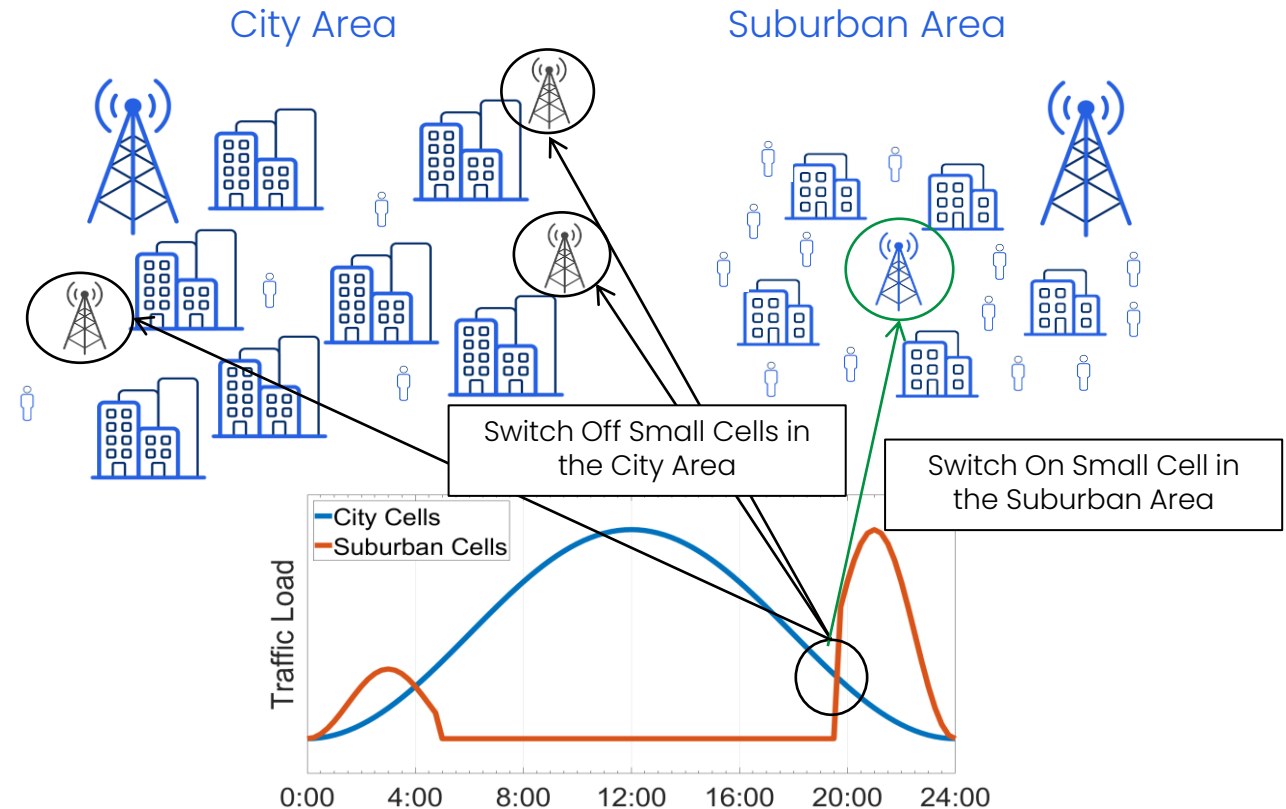

COOS in Self Organizing Network

- Called therein: Energy Saving Management
- Thresholds based
- SON: Not general but per use case
- Fallback procedure

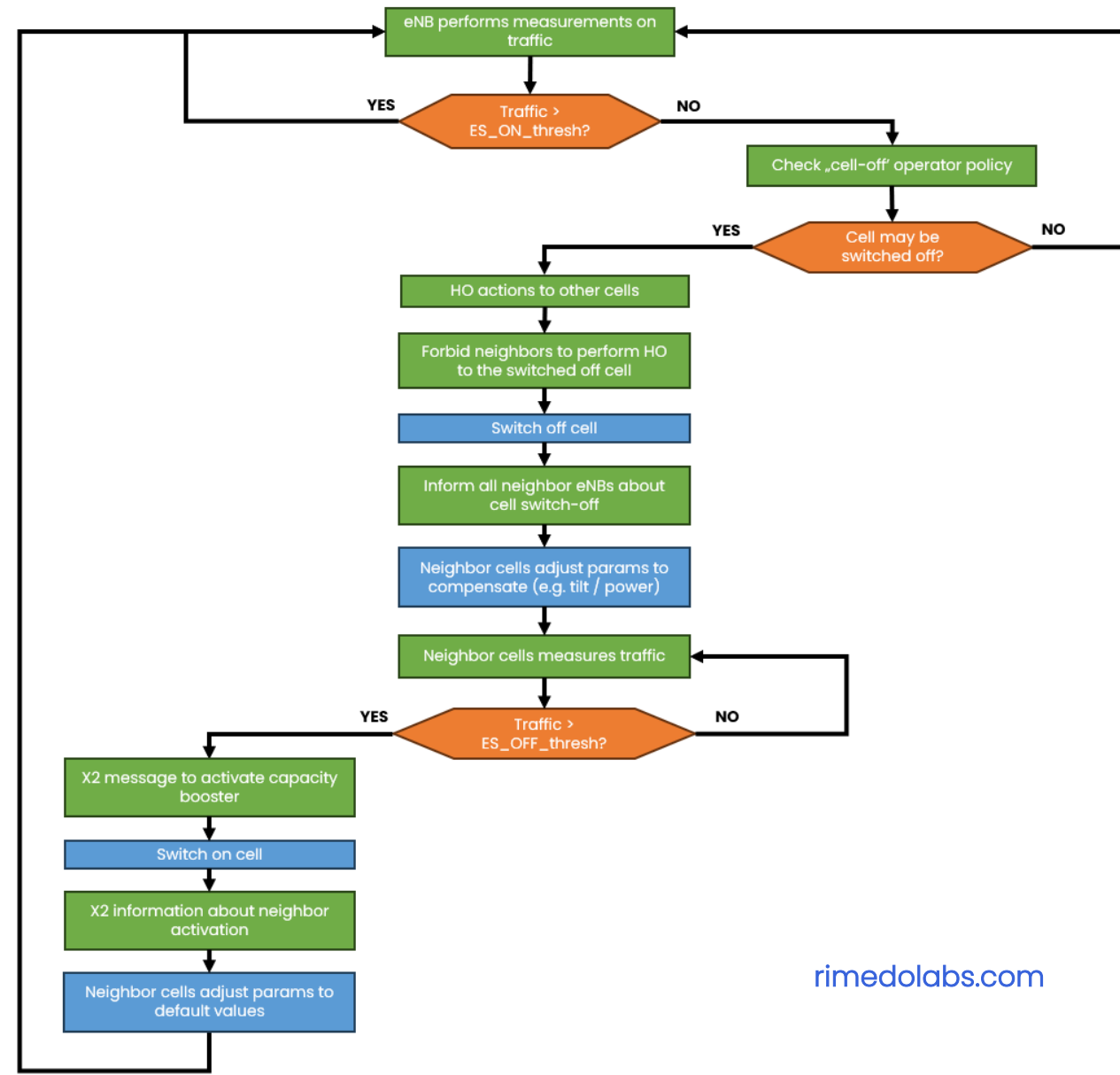

Architecture: COOS in O-RAN Alliance spec.

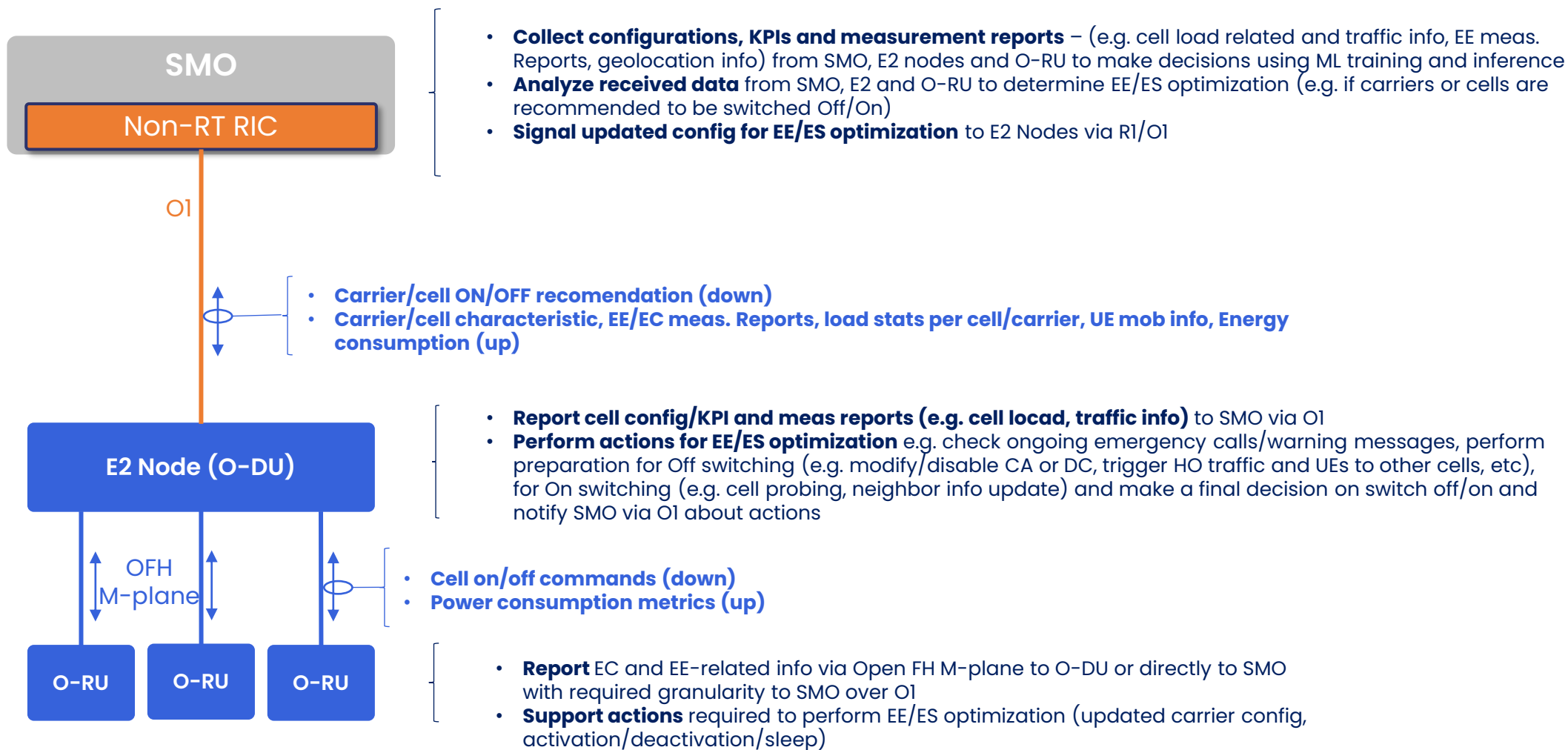

Architecture: COOS in O-RAN Alliance spec.

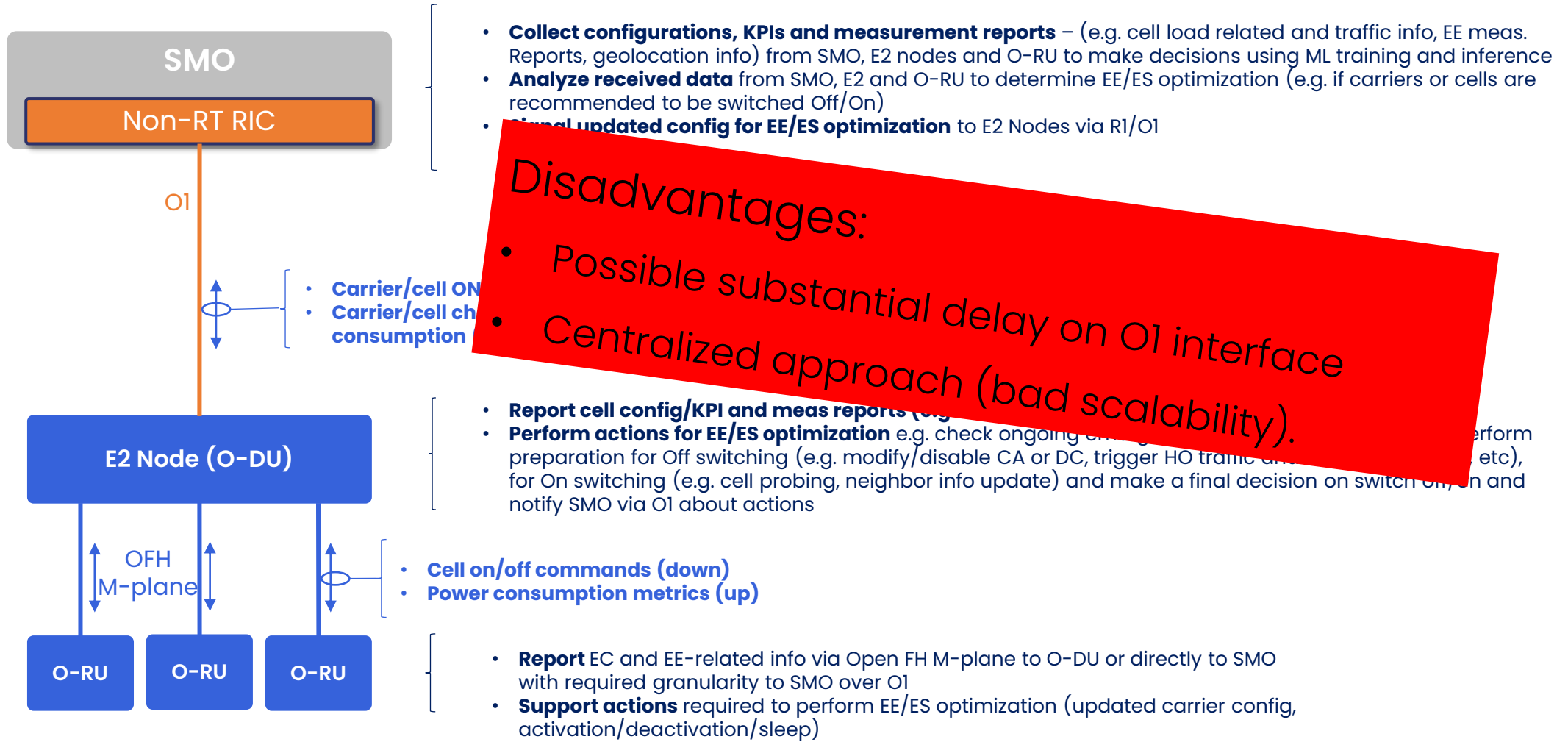

Disadvantages:

- Possible substantial delay on O1 interface
- Centralized approach (bad scalability).

Limitations in existing COOS algorithms

Limited scalability

- Spatial (small network, heterogenous including multifrequency), temporal (“per snapshot” decision)
- Computational complexity, control information (volume, delay) issue vs optimality

Exhaustive search vs real network

- Some cells cannot be turned OFF
- Limit on the number of tested COOS patterns (caused by: continuous network QoS, hardware failure probability increase): problem for many (especially Machine Learning) algorithms

“Typical network” vs realistic network

- Both traffic and sites deployment

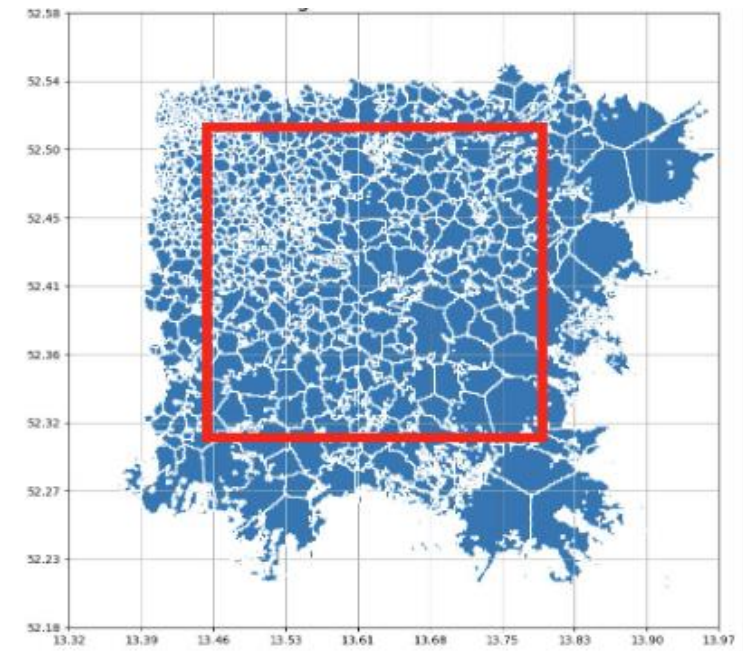
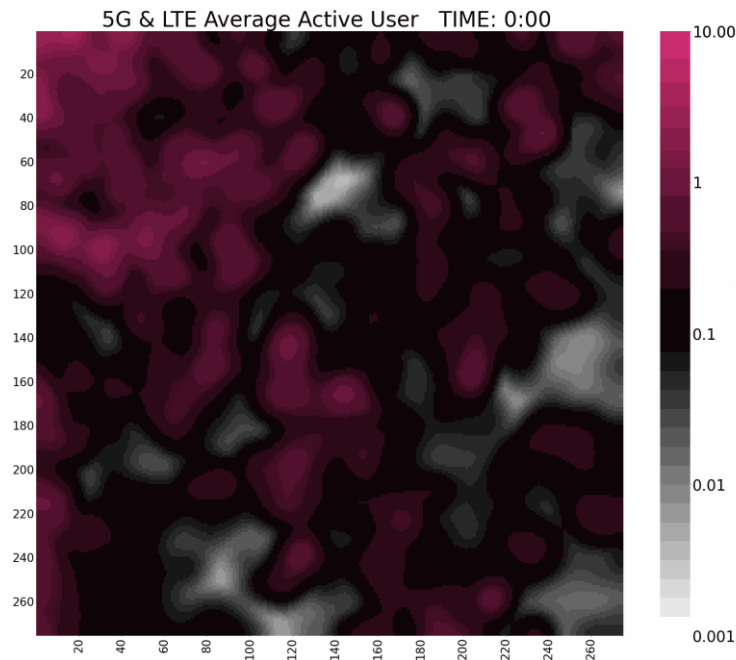
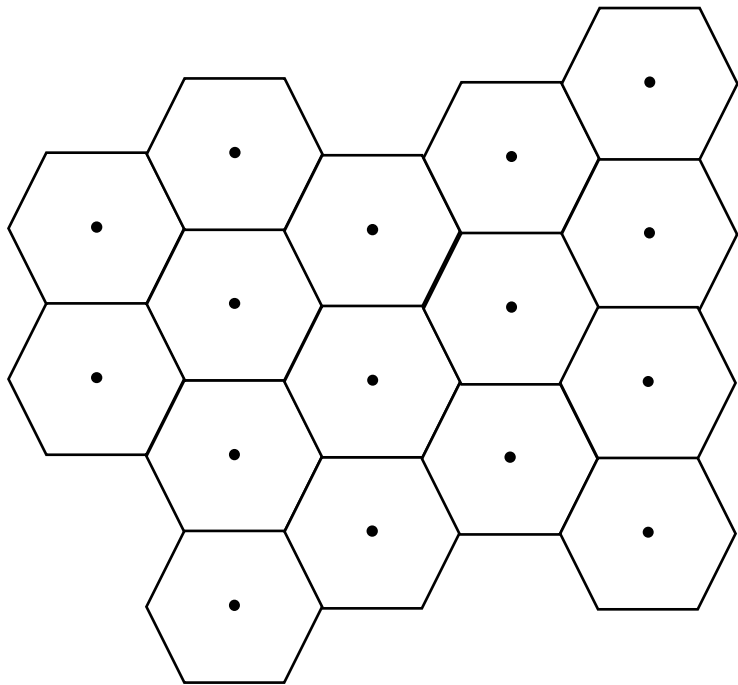

COOS algorithm: Requirements

Large & heterogeneous network:

- Parallel (“soft borders”) COOS in different cells but not adjacent (prevent ping-pong):
 - Turning OFF cells=increased load in adjacent cells
- “Parallel” but as continuous time optimization adjacent cells can block each other. Important order of checking cells for turn ON/OFF (not cell ID number)
- Works with various frequency and power (size) cells

Timescale:

- Operate “with memory” (no snapshot-like)
- Reactive to medium-term variations (e.g. react to instantaneous increased traffic in one network area) vs. long-term predictive (UEs demand changes depending on the hour of a day)

Load balancing – strong dependence:

- In time (COOS waits for TS result)
- COOS uses load (result of TS) as decision metric e.g., perfect Load balancing keeps equal load among cells vs keeping busy coverage cells

Algorithm topology

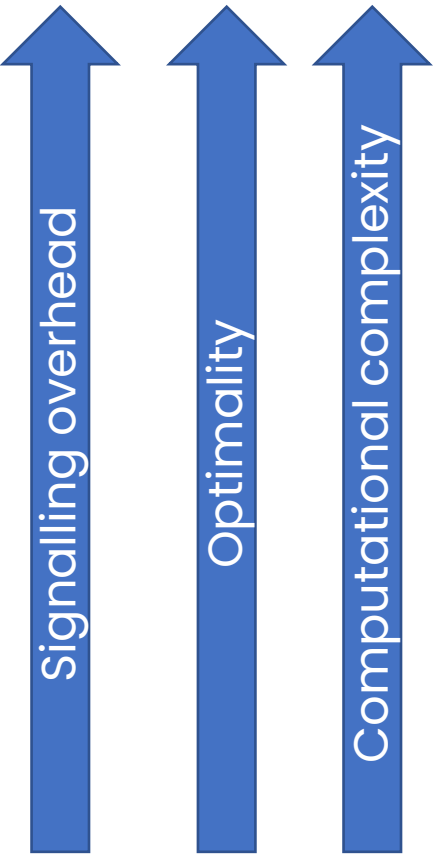

Centralized

Hierarchical

In O-RAN natural hierarchy between Near Real time RIC and NON-RT RIC

Distributed

COOS algorithm tandem

Global entity (all cells coordination):

- coordinate local optimization
- block cells (e.g. coverage layer)
- modify parameters (e.g. thresholds) of local entity to obtain given goal e.g., Energy Efficiency maximization
- Goal function with “soft borders” (not per cell- optimum to turn off cell)

Local entity (per cell operation):

- turn on/off single cell based on load metric (own for turn OFF, adjacent for turn ON)
- Each state change blocks this and adjacent cells for some time (reduces ping-pong)
- most of the computations and short-term control messages

Non-RT RIC

Near-RT RIC

E2 Nodes/Network

Apps tandem in O-RAN- limitations

- Main problem: ES rApp-> ES xApp interface. On AI only "ES policy exchanged", i.e., ES goal. One-way communications
- Can ES rApp and ES xApp come from different vendors? YES
- Advantage of rApp and xApp coming from the same vendor? YES (knowledge of internal behavior, goal function, etc.):

OUR UNDERSTANDING OF TANDEM APPS

- There is no way in the standard for the App to learn about other apps deployed (especially inter-RIC), only subscribe to specific messages e.g. revealing TS App is operating: maybe some "manifesto" should be exchanged?
- The coordination by a Non-RT RIC is important as a standard does not allow an interface between Near RT RICs.

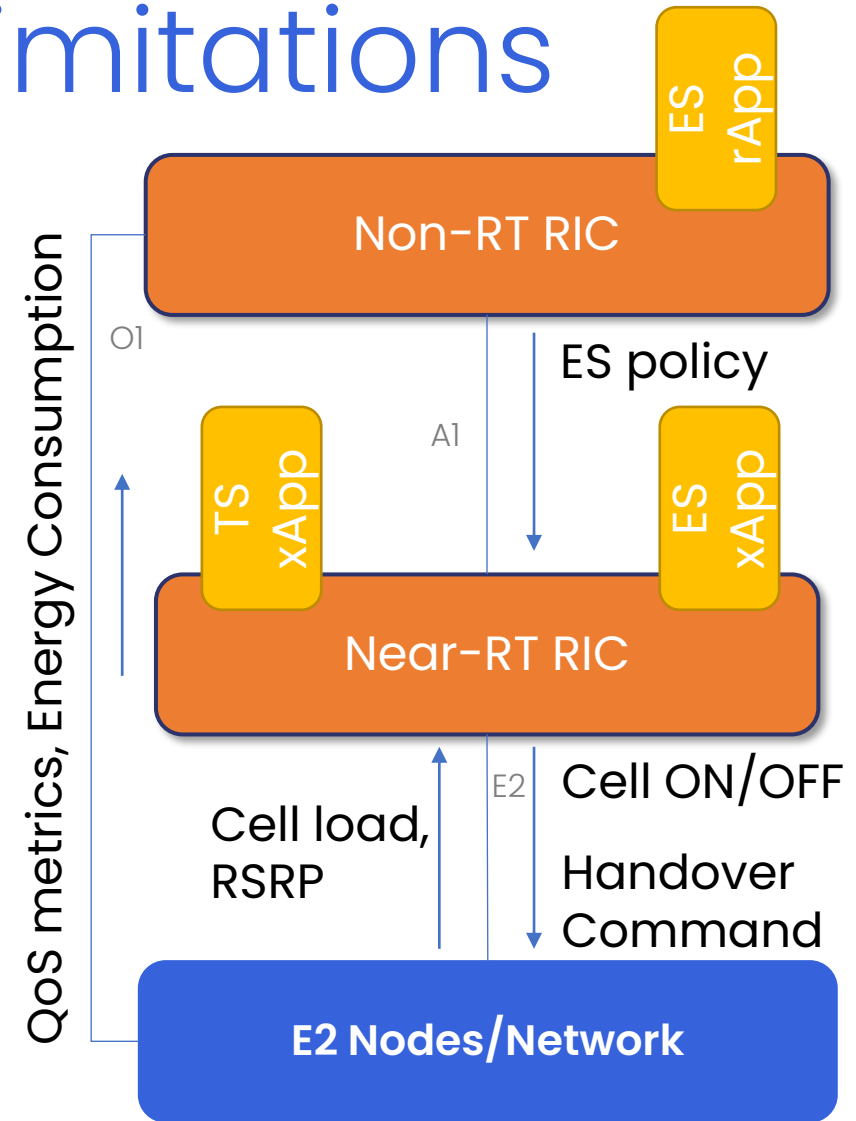

Demo/video





Summary

Summary

A vertical line of four dark blue circles, each connected to a horizontal blue bar containing text. The circles are positioned on the left side of the page, and the bars extend to the right.

Energy efficiency is one of the two most crucial topics for further O-RAN development

Cell ON/OFF switching one of the most mature in standard, algorithms, and real hardware (legacy)

Big, heterogenous networks, with realistic traffic can profit from Apps tandem deployment

The O-RAN standard limits information exchange between tandem Apps



Your trusted partner in:
O-RAN, 5G & Beyond,
Private Mobile Networks.

Let's keep in touch!

RIMEDO Labs

ul. Polanka 3
61-131 Poznan, Poland

info@rimedolabs.com

rimedolabs.com



The information contained herein is the property of RIMEDO and is provided only if it is not disclosed, directly or indirectly to a third party, or used for purposes other than those for which it was prepared.

ETSI is the copyright holder of LTE, LTE-Advanced and LTE Advanced Pro and 5G Logos. LTE is a trade mark of ETSI. RIMEDO is authorized to use the LTE, LTE-Advanced, LTE-Advanced Pro and 5G logos and the acronym LTE.

All information discussed in the document is provided "as is" and RIMEDO makes no warranty that this information is fit for purpose. Users use this information at their own risk and responsibility.

© 2024 RIMEDO sp. z o.o. All rights reserved.